

VRN2-10/M(R)

Size 10 (D05) • Q_{max} 150 l/min (40 GPM) • p_{max} 320 bar (4600 PSI)

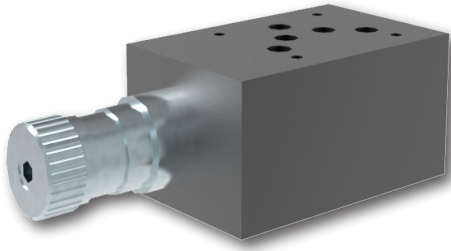

Technical Features

- › Pressure reducing - relieving valve, spool type, pilot operated with mounting interface acc. to ISO 4401, DIN 24340 (CETOP 05) or in-line design
- › Excellent stability throughout flow range with rapid response to dynamic pressure changes
- › Low hysteresis, accurate pressure control and low pressure drop
- › Reverse relief protection
- › Wide pressure range up to 320 bar
- › High flow capacity
- › Hardened precision parts
- › Adjustable by allen key or hand screw, optionally sealable (lockwire holes)
- › In the standard version, the valve housing is phosphated and steel parts are zinc-coated for 240 h protection acc. to ISO 9227

ISO 4401-05-04-0-05

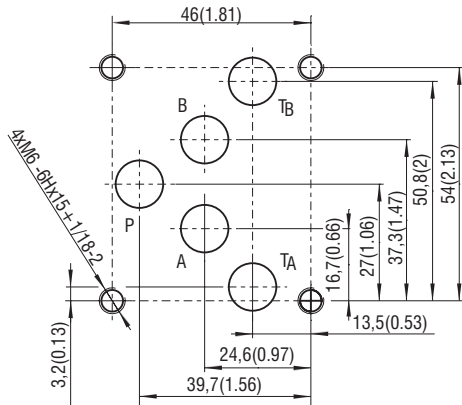

Ports P, A, B, T - max. \varnothing 11.2 mm (0.44 in)

Functional Description

This pilot operated pressure reducing valve is designed to reduce the system pressure at the consumer port. Its 3 way design provides reverse relief protection of the secondary circuit to the tank port. The pressure can be set by an adjustment screw and the valve is optionally equipped with lockwire holes for sealing. Valve bodies for vertical stacking assemblies are available with pressure reduction in ports A and P. Check valves incorporated into the valve bodies MA(B) enable the reverse flow to pass through the valve.

Model MA, MB

In models MA and MB, the flow enters the valve through port A1 (B1). The input pressure is reduced and routed to port A2 (B2). In model MB the reverse flow passes through a check valve.

Model MP

In model MP, the pressure is reduced from port P2 to port P1.

All models support the connection of a pressure gauge to port M (thread G 1/4).

Technical Data

Valve size / Cartridge cavity		Size 10 / K3
Max. flow	l/min (GPM)	150 (40)
Max. control flow	l/min (GPM)	0.65 (0.17)
Max. operating pressure (ports P, A, B)	bar (PSI)	320 (4640)
Max. operating pressure (port T)	bar (PSI)	160 (2320)
Fluid temperature range (NBR)	°C (°F)	-30 ... +100 (-22 ... 212)
Fluid temperature range (FPM)	°C (°F)	-20 ... +120 (-4 ... 248)
Weight - models MA, MB	kg (lbs)	3.20 (7.05)
- model MP		2.85 (6.28)
- model RA1		2.20 (4.85)
	Datasheet	Type
General information	GI_0060	Products and operating conditions
Mounting interface	SMT_0019	ISO 4401-05-04-0-05 DIN 24340 (CETOP 05)
Spare parts	SP_8010	



The volume flow, which is needed for control of output pressure and maintaining the adjusted value of reducing pressure, flows permanently through the pilot stage of valve.

Characteristics measured at $v = 32 \text{ mm}^2/\text{s}$ (156 SUS)

Reducing - relieving pressure related to flow rate

Relieving function A-T / Reducing function P-A

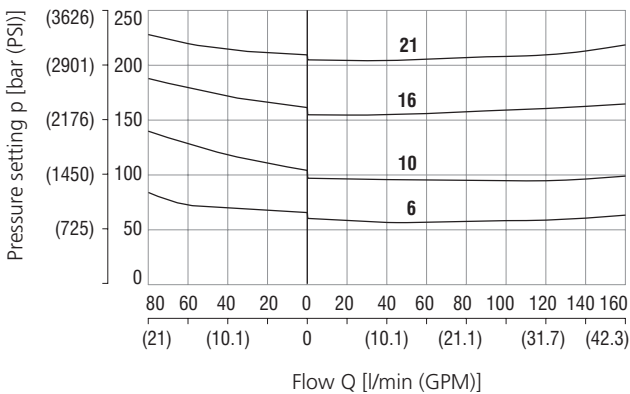

Pressure drop related to flow rate

Flow direction P-A Fully open valve through section

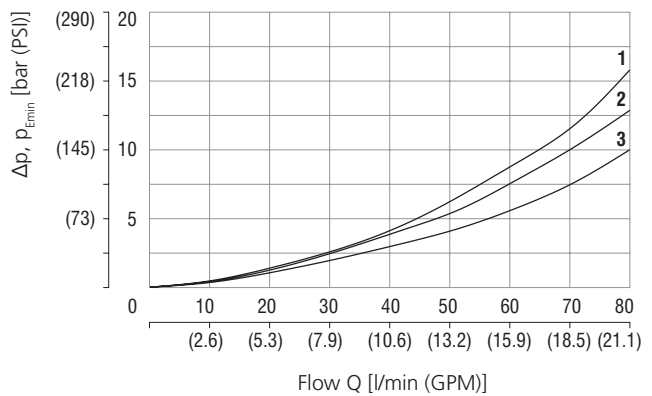

	Models	Directions
1	MA, MB	A-B, B1-B2
2	MP	P2-P1
3	MA, MB	A2-A1, B2-B1

Dimensions in millimeters (inches)

Model MA

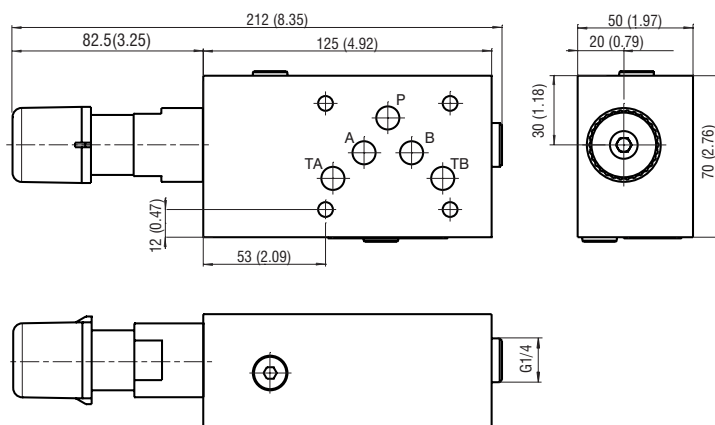

Model MB

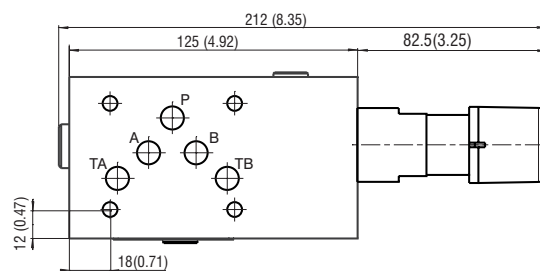

Dimensions in mm (in)			
Port	A	P	T
Thread	M27x2	G3/4	G1/2
Depth of thread	19 (0.75)	16 (0.63)	14 (0.55)
Counterbore	Ø40	Ø33	Ø28
Depth of counterbore	1 (0.04)	1 (0.04)	1 (0.04)

Model MP

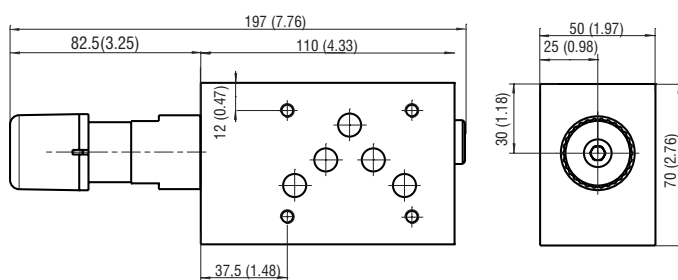

Model RA1

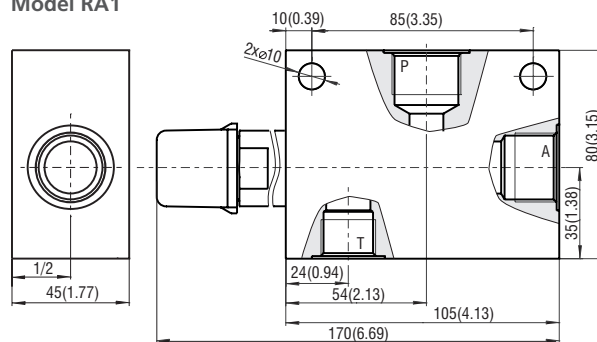

Functional Symbols

VRN2-10/MA

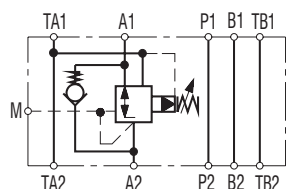

VRN2-10/MB

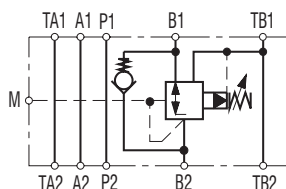

VRN2-10/MP

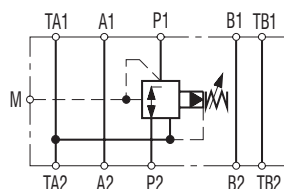

VRN2-10/RA1

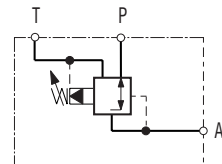

- ① valve side
- ② subplate or manifold side

Notice: The orientation of the symbol on the name plate corresponds with the valve function.

Ordering Code

VRN2-10/ - -

Pressure reducing - relieving valve, spool type, pilot operated, modular

Valve size
ISO 4401-05-04-0-05, DIN 24340 (CETOP 05), size 10

Model **Pressure reduction**
 modular valve, on port A2 (with by-pass check valve) **MA**
 modular valve, on port B2 (with by-pass check valve) **MB**
 modular valve, on port P1 **MP**
 in-line valve, three ports, thread G 3/4 (P), G 1/2 (T) **RA1**

Pressure range
 up to 63 bar (913 PSI) **6**
 up to 100 bar (1450 PSI) **10**
 up to 160 bar (2321 PSI) **16**
 up to 210 bar (3045 PSI) **21**

Surface treatment
 No designation standard
A zinc-coated (ZnCr-3), ISO 9227 (240 h)
B zinc-coated (ZnNi), ISO 9227 (520 h)

Seals
 No designation NBR
V FPM (Viton)

Adjustment option*
S allen key (hex. 6), without protective cap
T allen key (hex. 6), with protective cap
RS hand screw, metal
RP hand screw, plastic
L allen key (hex. 6), with protective cap, sealable (lockwire holes)

*for dimensions of adjustment options see data sheet No.5154